



## Thule Smart Panels

Thule Sun Blocker G2 - Front Panel

Thule Rain Blocker G2 - Front Panel

# > Instructions

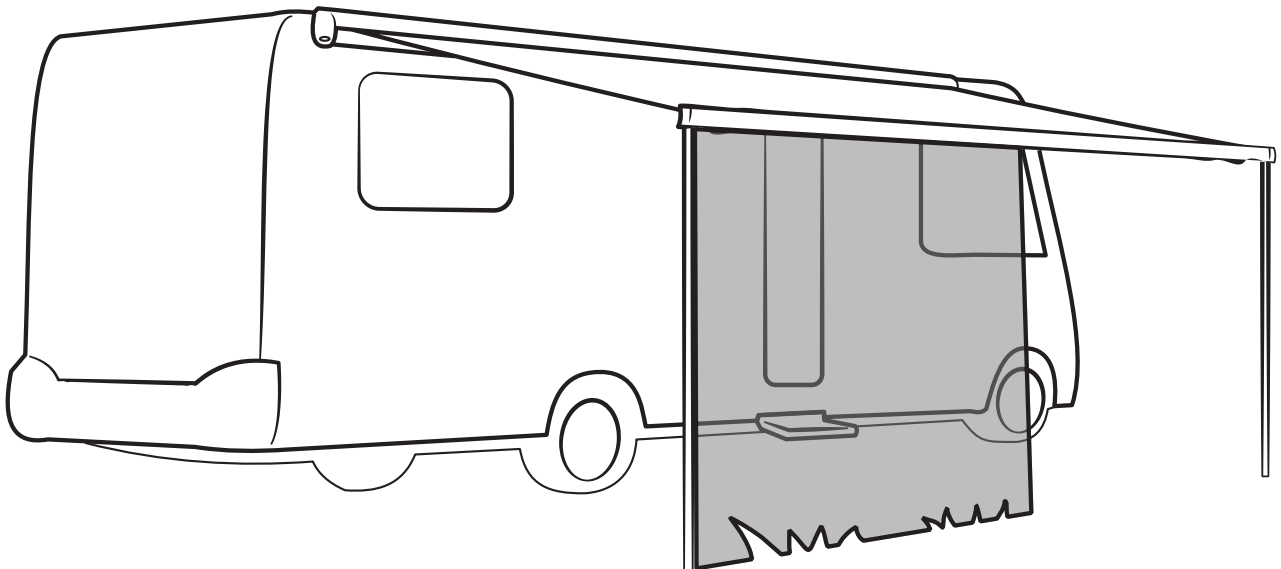

**Prod no.:** Various

**Document:** PNL910-02 // 3380038200

**Date:** 15/11/2018

**Bring your life**  
thule.com



Thule Sun Blocker G2  
Front Panel

		A	B	C	D	E	F
Thule Sun Blocker G2 Front Panel	1.00m	2	2	2	2	-	-
	2.40m ~ 2.80m	4	4	4	4	-	-
	3.30m ~ +	5	5	5	5	-	-



Thule Rain Blocker G2  
Front Panel

Thule Rain Blocker G2 Front Panel	1.00m	3	2	2	-	2	2
	1.25m ~ +	4	3	3	-	3	2



### Thule Sun Blocker G2 - Front Panel

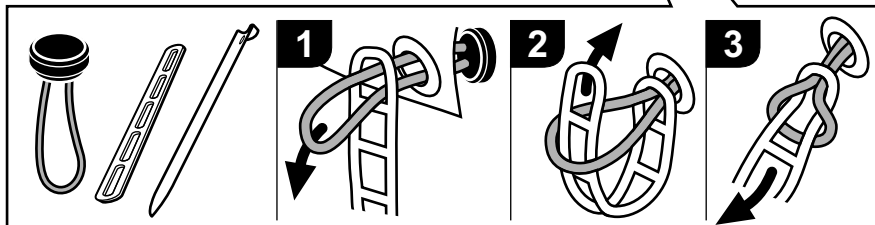
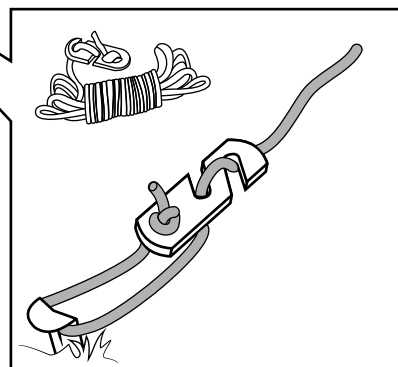
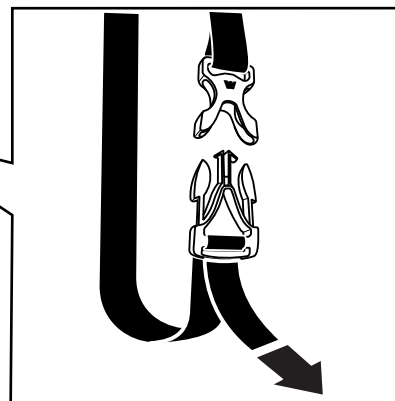
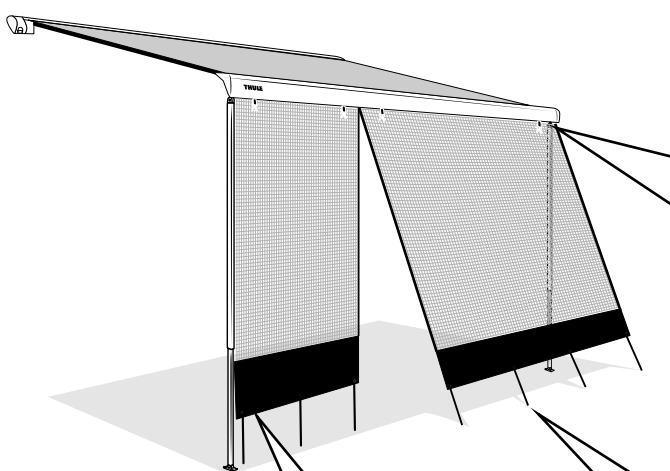
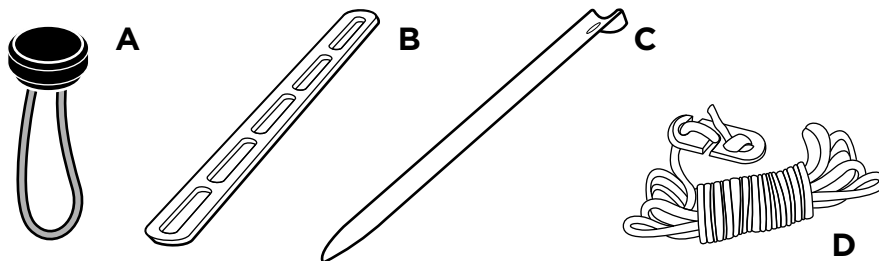
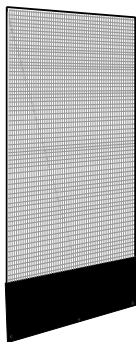
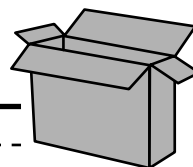



# Thule Rain Blocker G2 - Front Panel

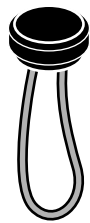
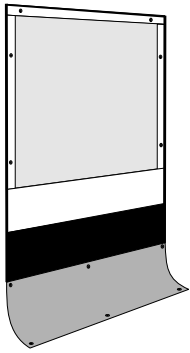
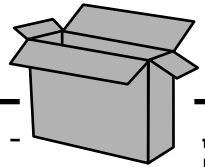

A

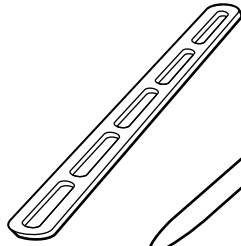

B

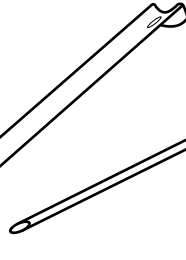

C



E



F

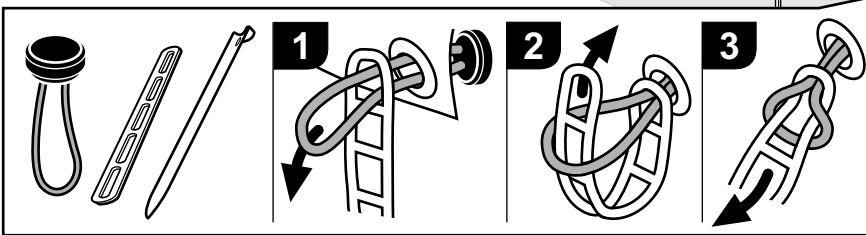
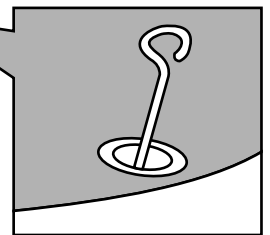
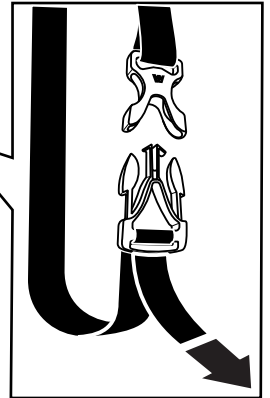
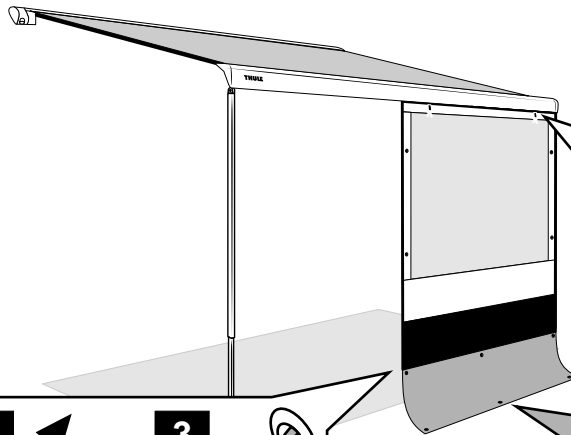

**i**

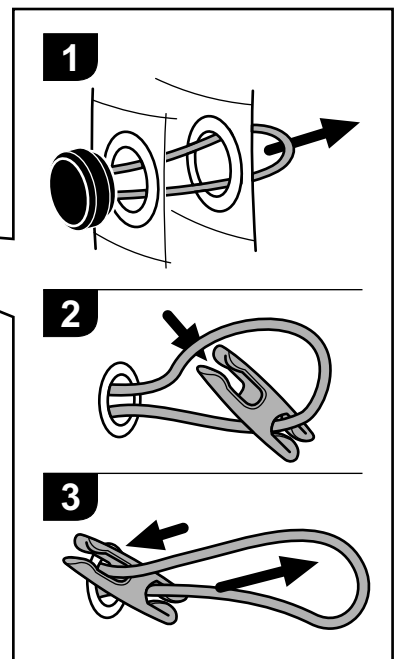
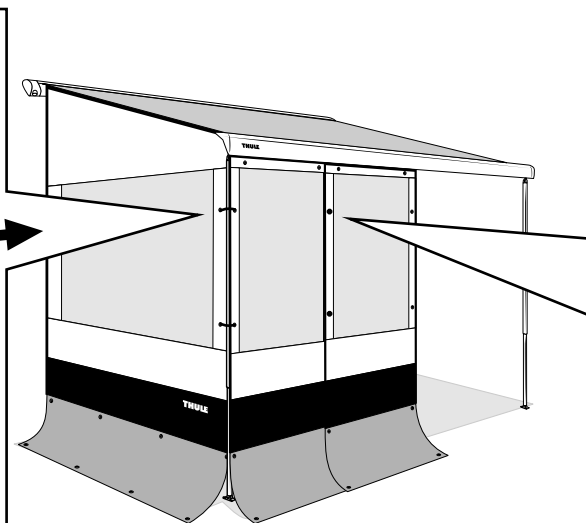
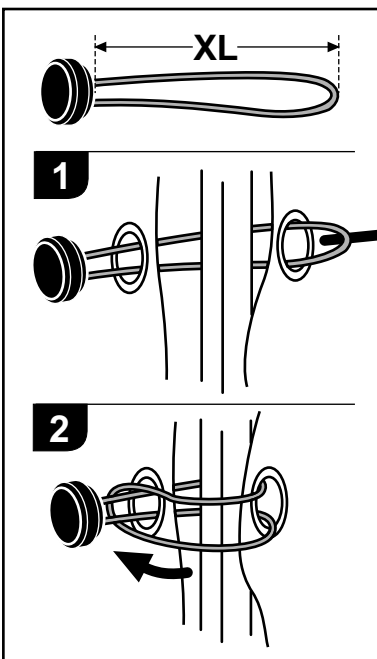

# Smart Panels

Some possible combinations

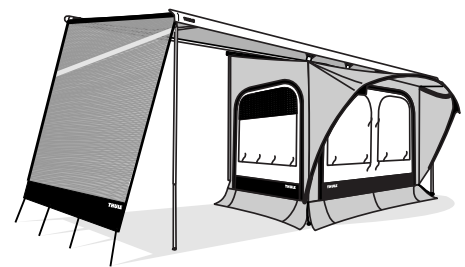
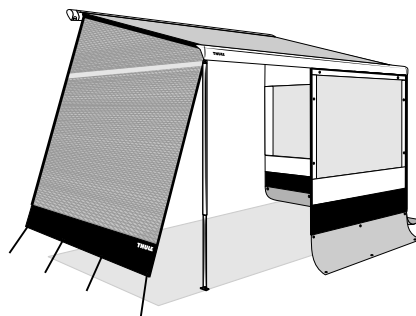
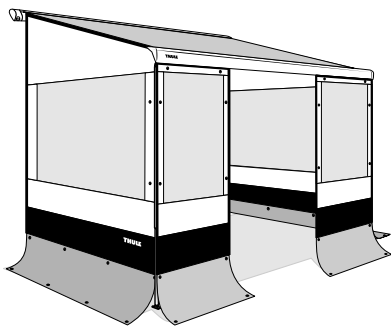
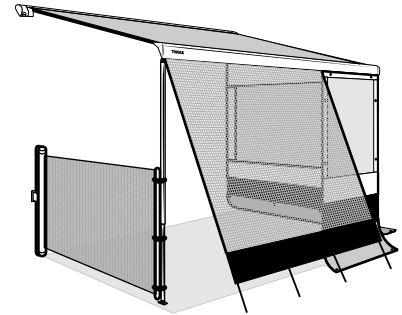
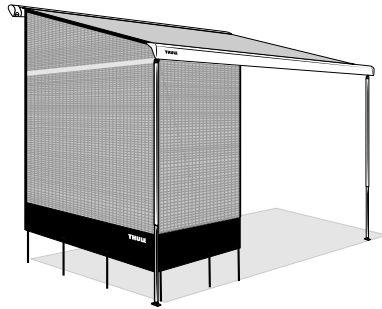
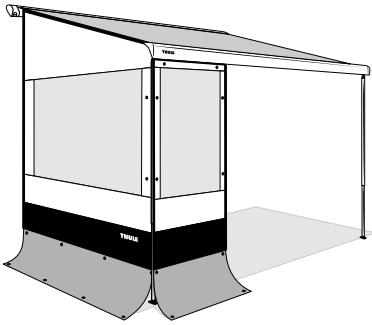

**306456**

Thule Windscreen

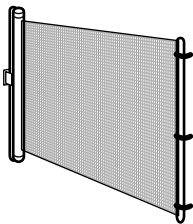

**Tent**

Thule QuickFit

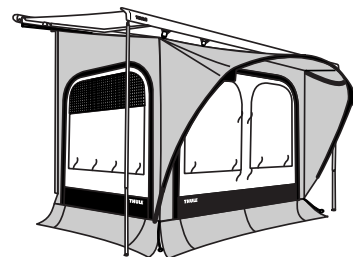

**Front**

Thule Sun Blocker G2  
Thule Rain Blocker G2

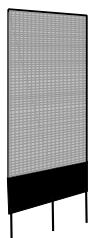
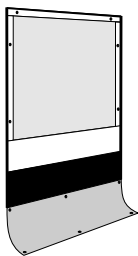

**Side**

Thule Sun Blocker G2  
Thule Rain Blocker G2  
Thule View Blocker G2

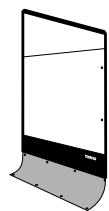
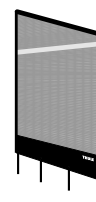
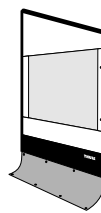

# Thule Rain Blocker Front G2

Available models

## MINIVAN

A

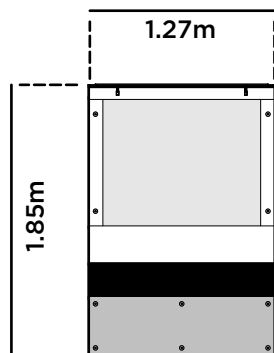

306454

## S / TO1200 V2

B

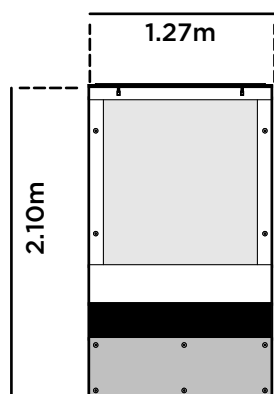

301320

C

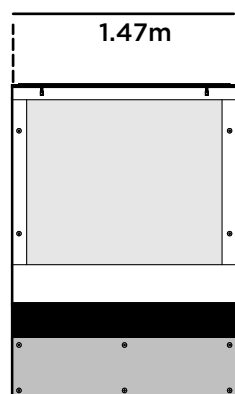

301321

D

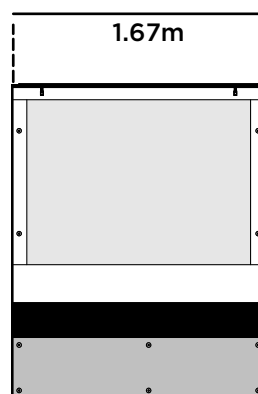

301322

E

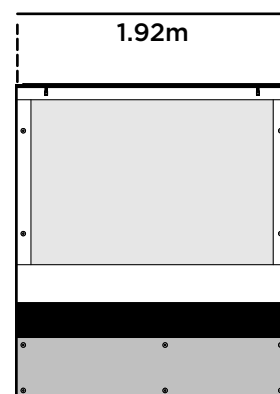

301323

## M / L / XL / XXL / VAN

F

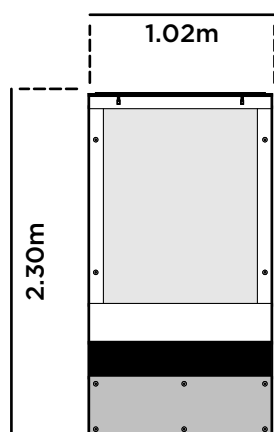

307303

G

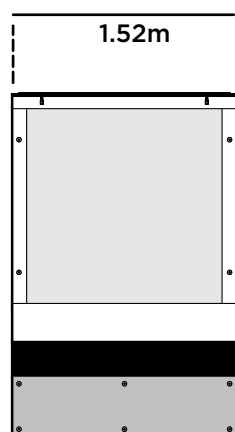

307304

H

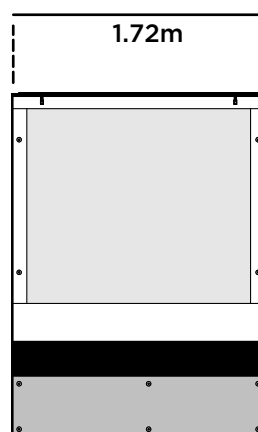

307305

I

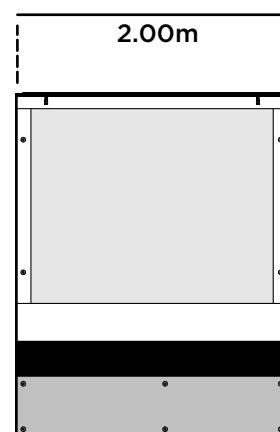

307306

# Thule Rain Blocker Front G2

Combinations for full awning length

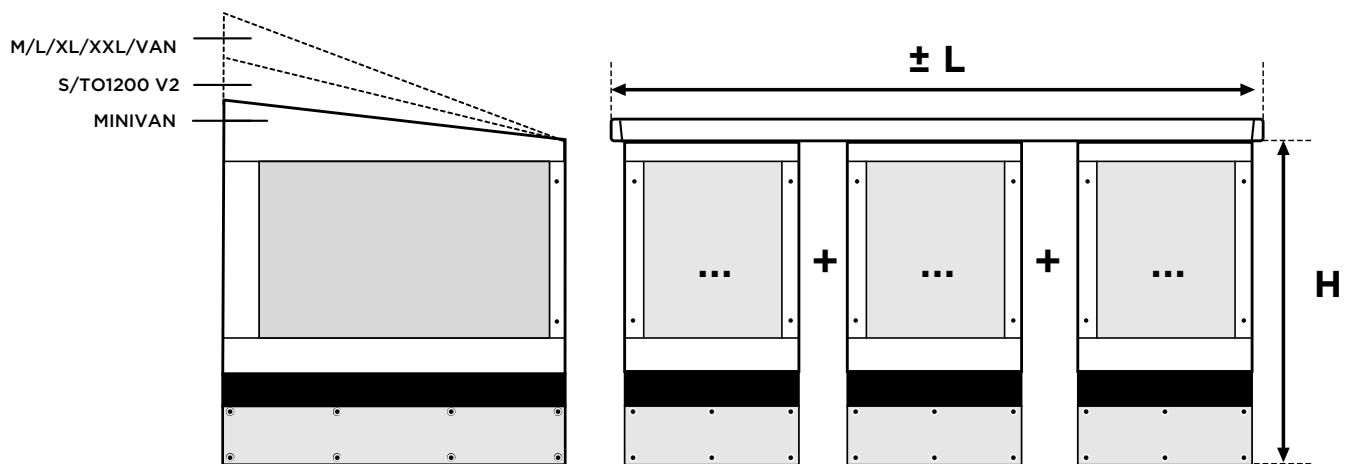

COMPATIBLE SIDE PANEL	AWNING LENGTH (L)	FRONT COMBINATION
MINIVAN	2.60m	A + A
S TO 1200 V2	2.60m	B + B
	2.80m	B + C
	3.00m	B + D
	3.25m	B + E
	3.50m	C + E
	3.75m	D + E
	4.00m	E + E
	4.25m	B + C + C
	4.50m	C + C + C
	5.00m	D + D + D
	5.50m	D + E + E
M L XL XXL VAN	3.00m	F + F + F
	3.25m	G + H
	3.50m	F + G + F
	3.75m	H + I
	4.00m	F + I + F
	4.25m	F + G + H
	4.50m	F + I + G
	5.00m	G + I + G
	5.50m	I + G + I
	6.00m	I + I + I

## EN

Read the instructions carefully. Wrong installation, use or repair voided warranty. If recovery is needed, consult a dealer.

### General remarks

- The amount of combinable panels depends on the awning type. Consult a dealer for further details.
- The sun can affect colors depending on usage.
- When it rains, put one side of the awning lower so that the water can drain.
- When wind reaches 6 Bft. please store the panels and close the awning.
- Don't place heat sources near the walls or the roof.

### Maintenance

- Ensure that there are no hard objects on the window during folding. This is to prevent impressions.
  - Let the panel dry thoroughly before long time storage.
  - Use pure water or a dry brush to clean the panel.
- 

## NL

Lees deze montage instructies aandachtig. Bij verkeerde montage, gebruik of eigenhandig herstel vervalt elke aanspraak op garantie. Indien herstel nodig is, raadpleeg een dealer.

### Algemene opmerkingen

- Het aantal panelen dat men kan combineren is afhankelijk van de luifel. Raadpleeg een dealer voor meer details.
- De zon kan kleuren aantasten afhankelijk van het gebruik.
- Zet bij regen één kant van de luifel wat lager zodat het water kan aflopen.
- Vanaf windkracht 6 Bft. gelieve de panelen op te bergen en uw luifel te sluiten.
- Geen warmtebronnen in de buurt van de wanden of het dak plaatsen.

### Onderhoud

- Zorg ervoor dat er geen harde voorwerpen op de ruit liggen tijdens het opvouwen. Dit om afdrukken te voorkomen.
  - Laat de panelen goed drogen alvorens op te bergen voor langere tijd.
  - Gebruik zuiver water of een droge borstel om de panelen te reinigen.
- 

## DE

Bitte lesen Sie die Montagevorschriften gründlich durch. Beiverkehrter Montage oder Änderung des Produkts entfallen alle Garantieansprüche. Im Falle von Reparaturen wenden Sie sich bitte an Ihren Fachhändler.

### Allgemeine Bemerkungen

- Die Anzahl der Thule Smart Blocker Modelle die kombiniert werden können, sind abhängig von der Markise. Bitte kontaktieren Sie für mehr Details Ihren Händler.
- Die Sonne kann Farben beeinflussen je nach Gebrauch
- Stellen Sie die Markise schräg für einen besseren Wasserablauf.
- Ab Windstärke 6 : das Produkt abbauen und die Markise einfahren.
- Keine Wärmequellen in der Nähe der Wände oder das Dach setzen.

### Unterhalt

- Vermeiden Sie beim Falten dass sich keine harten Gegenstände oder Schmutz mit einrollen. Es kann Abdrücke verursachen auf die Fensterfolie.
  - Lassen Sie den Wand gut austrocknen vor dem zusammenfallen für längere Zeit.
  - Benützen Sie nur sauberes Wasser und eine trockene weiche Bürste um das Produkt zu reinigen.
- 

## FR

Lisez attentivement les notices d'installation. Une mauvaise installation, utilisation ou propre réparation annule toute garantie. Si la réparation est nécessaire veuillez consulter votre revendeur.

### Remarques générales

- Les différentes combinaisons de panneaux dépendent de la longueur du store. Veuillez consulter votre revendeur pour plus d'informations.
- Dépendant de l'utilisation le soleil peut affecter le coloris de la toile
- Abaissez un pied de store pour obtenir un meilleur écoulement de l'eau en cas de pluie.
- À partir d'une force de vent de 6 Bft démontez le panneau et fermez le store.
- Ne placez aucune source de chaleur près des murs ou du toit.

### Maintenance

- Assurez-vous qu'il n'y a pas d'objets extérieurs sur la fenêtre lors du repliage. Ceci afin d'éviter des encoches dans la toile.
- Laissez sécher la toile complètement avant de la ranger de longue durée.
- Utilisez de l'eau claire ou une brosse sèche pour nettoyer.

